

*Wstap do klubu
dobrze wystanych*



łóżka



Box Multisystem Line	2 - 15
Box Continental Line	16 - 19
Łóżka Exclusive Line	20 - 25
Łóżka Modern Line	26 - 31
Dodatki	32
Zestawienie łóżek	33



łóżka

M&K Foam Sp. z o.o. ul.Toruńska 267, 62-600 Koło
tel.+48 63 26 24 300, fax +48 63 26 16 118
www.mkfoam.pl, e-mail: mkfoam@mkfoam.pl



zostań projektantem własnego łóżka

BOX
multi system

mkfoam multisystem line





KEL

(Korpus Elektro)

korpus: KEL-xx-40107/40106
 zagłówek: ZW-22-xx-40106



wymiary materaca

90 x 200	✓
100 x 200	
120 x 200	
140 x 200	✓
160 x 200	✓
180 x 200	✓
200 x 200	✓

kolory tkanin

grupa 1	✓
grupa 2	✓
grupa 3	✓
grupa 4	✓
grupa 5	✓

* np. grupa 1 tkanin zaczyna się od 10XXX

korpus: KEL-xx-40111/40114
 zagłówek: ZSD-27-xx-40114



korpus: KEL-xx-20066/20054
 zagłówek: ZS 30-xx-20054

MADE WITH
SWAROVSKI
 ELEMENTS

Wymiary zewnętrzne podane w cm

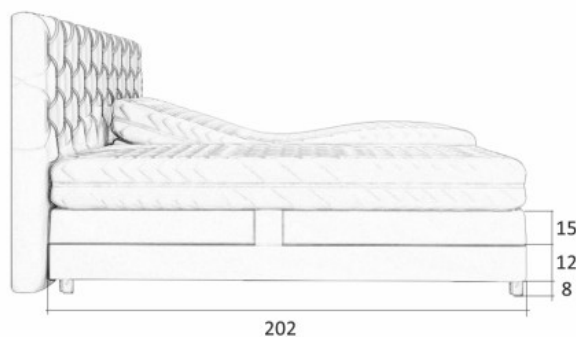
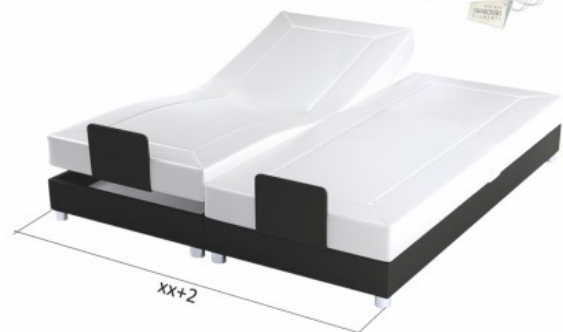

KBS

(Korpus Boki Szerokie)

korpus: KBS-xx-50068
 nóżki: srebrne (w komplecie)
 zagłówek: ZS 16-xx-20066/50068



wymiary materaca

90 x 200	✓
100 x 200	
120 x 200	✓
140 x 200	✓
160 x 200	✓
180 x 200	✓
200 x 200	✓

kolory tkanin

grupa 1	✓
grupa 2	✓
grupa 3	✓
grupa 4	✓
grupa 5	✓

* np. grupa 1 tkanin
 zaczyna się od 10XXX

korpus: KBS-xx-30187
 nóżki: srebrne (w komplecie)
 zagłówek: ZS 14-xx-30187



Wymiary zewnętrzne podane w cm

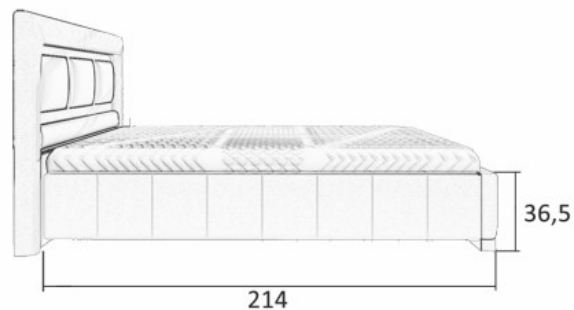

korpus: KBS-xx-40115
 nóżki: srebrne (w komplecie)
 zagłówek: ZS 05-xx-40107 / 40115
 szafka: 80683-40115

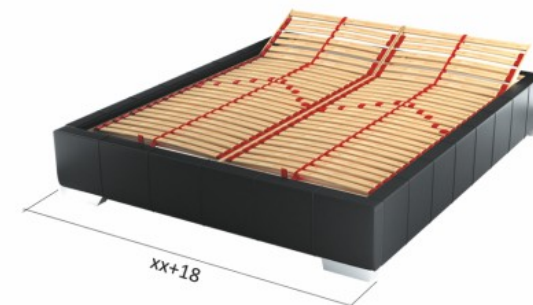



KSS

(Korpus Skrzynia Side)

korpus: KSS-xx-50068/50075
zagłówek: ZSD 22-xx-50068



wymiary materaca

90 x 200	
100 x 200	
120 x 200	✓
140 x 200	✓
160 x 200	✓
180 x 200	
200 x 200	

kolory tkanin

grupa 1	✓
grupa 2	✓
grupa 3	✓
grupa 4	✓
grupa 5	✓

* np. grupa 1 tkanin zaczyna się od 10XXX

korpus: KSS-xx-10107/10111
zagłówek: ZW 23-xx-10111

korpus: KSS-xx-1K800/1K110
zagłówek: ZW 01-xx-1K110
szafka: 80684-1K110

MADE WITH
SWAROVSKI
ELEMENTS

Wymiary zewnętrzne podane w cm

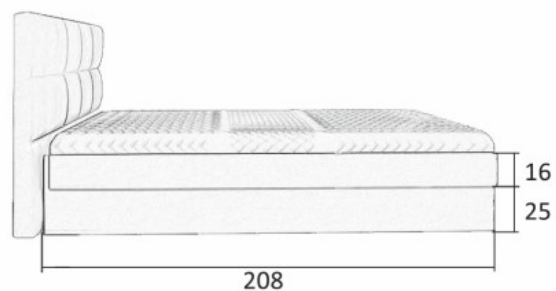

KSRM

(Korpus Skrzynia Rama Metalowa)

korpus: KSRM-xx-10242
 zagłówek: ZW 04-xx-10242/10040



wymiary materaca

90 x 200	✓
100 x 200	
120 x 200	✓
140 x 200	✓
160 x 200	✓
180 x 200	✓
200 x 200	

kolory tkanin

grupa 1	✓
grupa 2	✓
grupa 3	✓
grupa 4	✓
grupa 5	✓

* np. grupa 1 tkanin
 zaczyna się od 10XXX

korpus: KSRM-xx-40114
 zagłówek: ZS 08-xx-40103



Wymiary zewnętrzne podane w cm

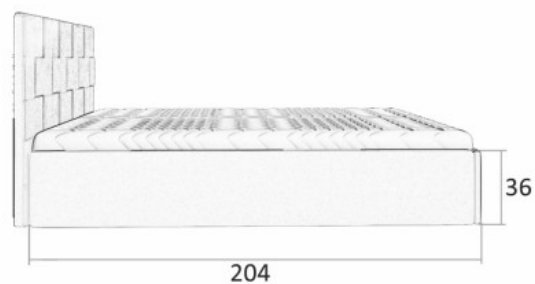

korpus: KSRM-xx-50068
 zagłówek: ZW 25-xx-50068





KBO

(Korpus Boki)

korpus: KBO-xx-20050
zagłówek: ZS 12-xx-20050



wymiary materaca

90 x 200	✓
100 x 200	
120 x 200	✓
140 x 200	✓
160 x 200	✓
180 x 200	✓
200 x 200	✓

kolory tkanin

grupa 1	✓
grupa 2	✓
grupa 3	✓
grupa 4	✓
grupa 5	✓

* np. grupa 1 tkanin zaczyna się od 10XXX

korpus: KBK-xx-30330
zagłówek: ZS 10-xx-30329

korpus: KBO-xx-50075
zagłówek: ZS 11-xx-50072

MADE WITH
SWAROVSKI
ELEMENTS

Wymiary zewnętrzne podane w cm

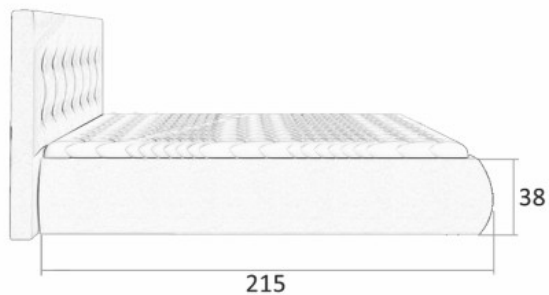
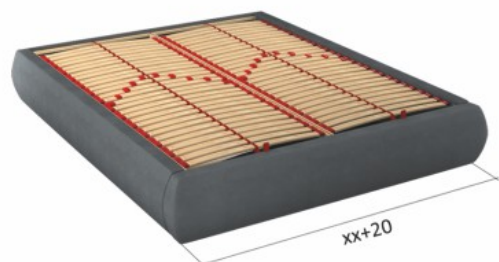

KRA

(Korpus Rama)

korpus: KRA-xx-40103
 nóżki: Box N-99
 zagłówek: ZS 03-xx-20050



wymiary materaca

90 x 200	✓
100 x 200	
120 x 200	✓
140 x 200	✓
160 x 200	✓
180 x 200	✓
200 x 200	✓

kolory tkanin

grupa 1	✓
grupa 2	✓
grupa 3	✓
grupa 4	✓
grupa 5	✓

* np. grupa 1 tkanin
 zaczyna się od 10XXX

korpus: KRA-xx-40106
 nóżki: Box N-99
 zagłówek: ZS 02-xx-40103



Wymiary zewnętrzne podane w cm

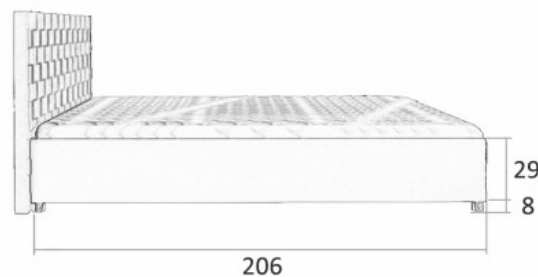

korpus: KRA-xx-20066
 nóżki: Box N-99
 zagłówek: ZW 31-xx-20066
 szafka: 80675-20066

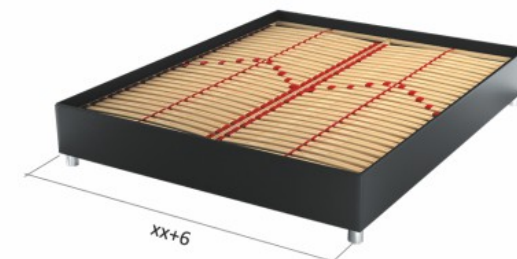



KP2

(Korpus Podstawa pod Materac dwuczęściowy)

korpus: KP2-xx-30355
 nóżki: Box N-99
 zagłówek: ZS 16-xx-30355/30354



wymiary materaca

90 x 200	✓
100 x 200	
120 x 200	✓
140 x 200	✓
160 x 200	✓
180 x 200	✓
200 x 200	✓

kolory tkanin

grupa 1	✓
grupa 2	✓
grupa 3	✓
grupa 4	✓
grupa 5	✓

* np. grupa 1 tkanin zaczyna się od 10XXX

korpus: KP2-xx-10107
 nóżki: Box N-99
 zagłówek: ZS 06-xx-10107

korpus: KP2-xx-30350
 nóżki: Box N-99
 zagłówek: ZW 17-xx-30350
 szafka: 80670-30350

Wymiary zewnętrzne podane w cm

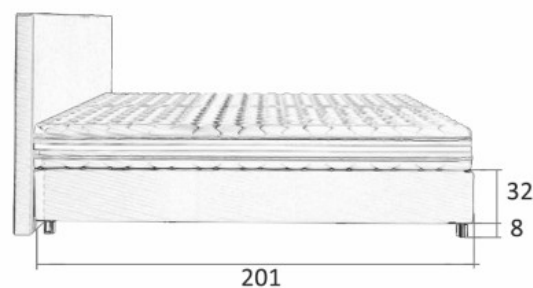

KKF

(Korpus Boki Szerokie)

korpus: KKF-xx-30349
zagłówek: ZS 23-xx-30349



wymiary materaca

90 x 200	
100 x 200	
120 x 200	
140 x 200	✓
160 x 200	✓
180 x 200	✓
200 x 200	

kolory tkanin

grupa 1	✓
grupa 2	✓
grupa 3	✓
grupa 4	✓
grupa 5	✓

* np. grupa 1 tkanin zaczyna się od 10XXX

korpus: KKF-xx-30351
zagłówek: ZS 17-xx-30351



Wymiary zewnętrzne podane w cm

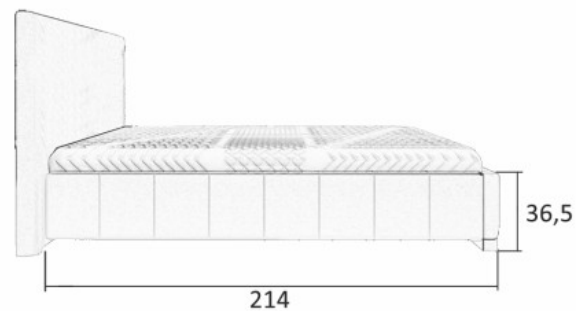

korpus: KKF-xx-20066
zagłówek: ZS 28-xx-20066
szafka: 80687-20066

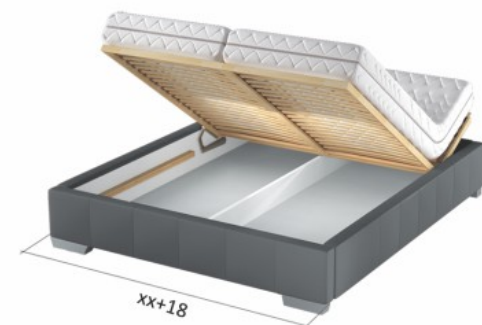

TIK

(Korpus TIK)

korpus: TIK-xx-30331
 nogi: NOG-ZD-TIK-CZ
 zagłówek: ZSD 27-xx-30331



wymiary materaca

90 x 200	✓
100 x 200	✓
120 x 200	✓
140 x 200	✓
160 x 200	✓
180 x 200	✓
200 x 200	✓

kolory tkanin

grupa 1	✓
grupa 2	✓
grupa 3	✓
grupa 4	✓
grupa 5	✓

* np. grupa 1 tkanin zaczyna się od 10XXX

korpus: TIK-xx-50063
 nogi: NOG-ZD-TIK-BR
 zagłówek: ZW 31-xx-50063



korpus: TIK-xx-30375
 nogi: NOG-ZD-TIK-BR
 zagłówek: ZW 22-xx-30375

Wymiary zewnętrzne podane w cm

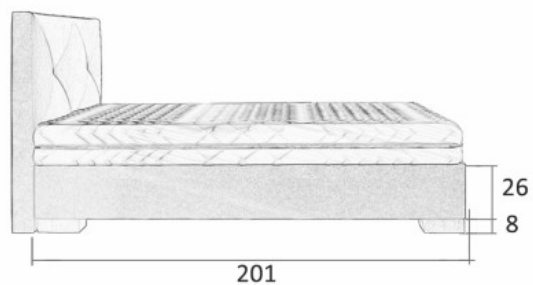
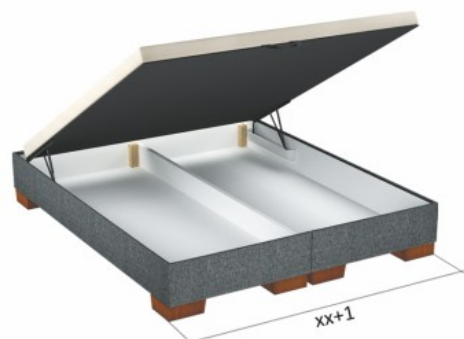

ZAGŁÓWKI (ZW-wąskie, ZS-szerokie, ZSD-szerokie dopasowane)

wymiary zewnętrzne podane w cm

BOX multi system



ZS 01-xx-20054

symp.	wys.	szer.	gr.
ZW 01	104	/xx+6/	10
ZS 01	104	/xx+44/	10
ZSD 01	104	/xx+21/	10

MADE WITH SWAROVSKI ELEMENTS



ZS 03-xx-30187

symp.	wys.	szer.	gr.
ZW 03	105	/xx+6/	9
ZS 03	105	/xx+44/	9
ZSD 03	105	/xx+21/	9



ZS 04-xx-10242/10232

symp.	wys.	szer.	gr.
ZW 04	104	/xx+7/	9
ZS 04	104	/xx+45/	9
ZSD 04	105	/xx+22/	9



ZS 05-xx-20054/30194

symp.	wys.	szer.	gr.
ZW 05	105	/xx+6/	8
ZS 05	105	/xx+44/	8
ZSD 05	105	/xx+21/	8



ZS 06-xx-20021

symp.	wys.	szer.	gr.
ZW 06	104	/xx+6/	8
ZS 06	104	/xx+44/	8
ZSD 06	104	/xx+21/	8



ZS 07-xx-20054

symp.	wys.	szer.	gr.
ZW 07	104	/xx+6/	9
ZS 07	104	/xx+44/	9
ZSD 07	104	/xx+21/	9



ZS 08-xx-30187/30189

symp.	wys.	szer.	gr.
ZW 08	104	/xx+6/	10
ZS 08	104	/xx+44/	10
ZSD 08	104	/xx+21/	10



ZS 09-xx-20014

symp.	wys.	szer.	gr.
ZW 09	104	/xx+6/	13
ZS 09	104	/xx+44/	13
ZSD 09	104	/xx+21/	13



ZS 10-xx-30186

symp.	wys.	szer.	gr.
ZW 10	86	/xx+6/	25
ZS 10	86	/xx+44/	25
ZSD 10	86	/xx+21/	25

odległość od ściany ok. 25cm



ZS 11-xx-40112

symp.	wys.	szer.	gr.
ZW 11	87	/xx+6/	25
ZS 11	87	/xx+44/	25
ZSD 11	87	/xx+21/	25

odległość od ściany ok. 25cm



ZS 12-xx-30321

symp.	wys.	szer.	gr.
ZW 12	105	/xx+6/	9
ZS 12	105	/xx+44/	9
ZSD 12	105	/xx+21/	9



ZS 14-xx-30189

symp.	wys.	szer.	gr.
ZW 14	104	/xx+6/	9
ZS 14	104	/xx+44/	9
ZSD 14	104	/xx+21/	9

ZS 15-xx-40114



symb.	wys.	szer.	gr.
ZW 15	104	/xx+6/	10
ZS 15	104	/xx+44/	10
ZSD 15	104	/xx+21/	10

ZS 23-xx-10109



symb.	wys.	szer.	gr.
ZW 23	123	/xx+11/	12
ZS 23	123	/xx+50/	12
ZSD 23	123	/xx+26/	12

ZS 27-xx-10161



symb.	wys.	szer.	gr.
ZW 27	104	/xx+6/	9
ZS 27	104	/xx+44/	9
ZSD 27	104	/xx+21/	9

ZS 16-xx-30189/30194



symb.	wys.	szer.	gr.
ZW 16	104	/xx+6/	5
ZS 16	104	/xx+44/	5
ZSD 16	104	/xx+21/	5

ZS 24-xx-40109



symb.	wys.	szer.	gr.
ZS 24	123	/xx+44/	14
ZSD 24	123	/xx+21/	14

ZS 28-xx-40107



symb.	wys.	szer.	gr.
ZW 28	104	/xx+7/	12
ZS 28	104	/xx+45/	12
ZSD 28	104	/xx+22/	12

ZS 17-xx-20066



symb.	wys.	szer.	gr.
ZW 17	122	/xx+13/	36
ZS 17	122	/xx+52/	36
ZSD 17	122	/xx+36/	36

ZS 25-xx-40103



symb.	wys.	szer.	gr.
ZW 25	106	/xx+10/	10
ZS 25	106	/xx+48/	10
ZSD 25	106	/xx+26/	10

ZS 30-xx-20054



symb.	wys.	szer.	gr.
ZW 30	104	/xx+6/	11
ZS 30	104	/xx+44/	11
ZSD 30	104	/xx+21/	11

MADE WITH
SWAROVSKI
ELEMENTS

ZS 22-xx-10107



symb.	wys.	szer.	gr.
ZW 22	116	/xx+6/	13
ZS 22	116	/xx+44/	13
ZSD 22	116	/xx+21/	13

ZS 26-xx-30349



symb.	wys.	szer.	gr.
ZW 26	118	/xx+6/	10
ZS 26	118	/xx+44/	10
ZSD 26	118	/xx+21/	10

ZS 31-xx-30352



symb.	wys.	szer.	gr.
ZW 31	118	/xx+10/	12
ZS 31	118	/xx+48/	12
ZSD 31	118	/xx+26/	12

KORPUSY (KSS, KSZ, KSD, KBO, KBK, KBRM, KEL, KRA, KSRM, KSV, KBS, KKF, KRM, KB2, KPO, KP2)

BOX multi system

KSS - korpus skrzynia side ze stelażem i pojemnikiem na pościel



symb. długość szer. wysokość
KSS 208 /xx+5/ 41

KSS, KSZ, KSD
na ślizgaczach bez nóżek

KSZ - korpus skrzynia zmontowana ze stelażem i pojemnikiem na pościel

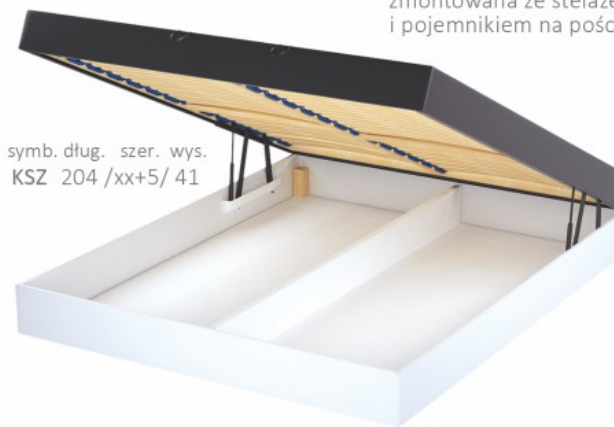

symb. długość szer. wysokość
KSZ 204 /xx+5/ 41

KSD - korpus skrzynia do montażu ze stelażem i pojemnikiem na pościel

KSD-stelaż występuje w całości, a do montażu jest pojemnik na pościel

KBO - korpus boki (np. stelaż Duoflex NV-2szt)



symb. długość szer. wysokość
KBO 215 /xx+20/ 38

KBK - korpus boki KF ze stelażem i pojemnikiem na pościel

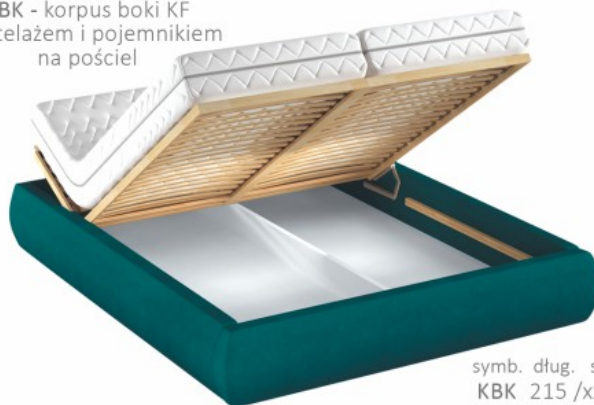

symb. długość szer. wysokość
KBK 215 /xx+20/ 38

KBRM - korpus boki rama metalowa ze stelażem i pojemnikiem na pościel

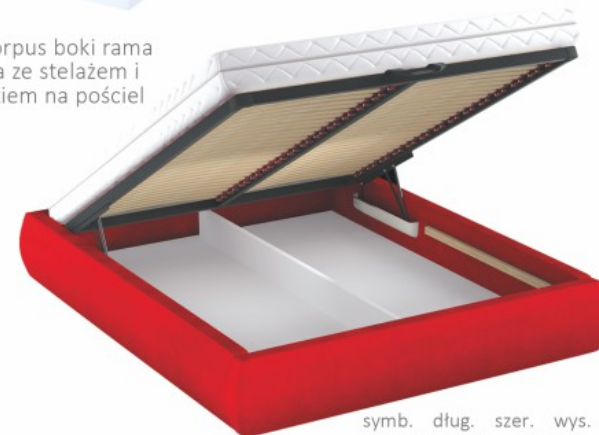

symb. długość szer. wysokość
KBRM 215 /xx+20/ 38

KEL - korpus elektro (nóżki Box -8 szt.)



symb. długość szer. wysokość
KEL 202 /xx+2/ 35

KBO, KBK, KBRM
na ślizgaczach bez nóżek
Uwaga dla KBO, KBK, KBRM
stosujemy tylko zagłówki ZS i ZSD

dla
KEL, KRA
nóżki Box do wyboru
wysokość nóżek-8 cm



KRA - korpus rama (np. stelaż Duoflex NV-2szt, nóżki Box -4 szt)

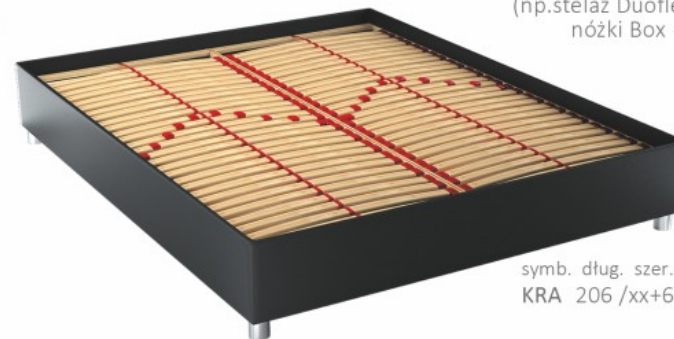

symb. długość szer. wysokość
KRA 206 /xx+6/ 38

wymiary zewnętrzne podane w cm

BOX multi system

Zostań projektantem własnego łóżka

KSRM - korpus skrzynia rama metalowa na ślizgaczach bez nóżek



symb. długość szer. wysokość
KSRM 204 /xx+6/ 36

TIK - korpus ze stelażem drewnianym w materiale tapicerskim na siłownikach gazowych i pojemnikiem na pościel. (nogi do korpusu TIK lub Box -8 szt.)

symb. długość szer. wysokość
TIK 201 /xx+1/ 34



KBS - korpus boki szeroki (np. stelaż Duoflex KF-2szt.)



symb. długość szer. wysokość
KBS 214 /xx+18/ 36,5

KKF - korpus szeroki KF ze stelażem i pojemnikiem na pościel

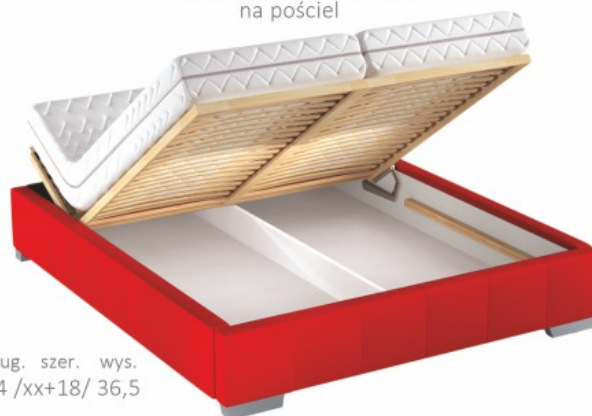

symb. długość szer. wysokość
KKF 214 /xx+18/ 36,5

KRM - korpus szeroki rama metalowa ze stelażem i pojemnikiem na pościel



symb. długość szer. wysokość
KRM 214 /xx+18/ 36,5

KB2 - korpus boki 2 (w komplecie nóżki srebrne-8szt.)



symb. długość szer. wysokość
KB2 200 / xx / 55

KPO - korpus podstawa pod materac (nóżki Box- ilość szt. uzależniona od rozmiaru korpusu)



symb. długość szer. wysokość
KPO 201 /xx+2/ 30

KBS, KKF, KRM w komplecie nóżki srebrne
Uwaga dla **KBS, KKF, KRM** stosujemy tylko zagłówki ZS i ZSD

KP2 - korpus podstawa pod materac (nóżki Box- ilość szt. uzależniona od rozmiaru korpusu)



symb. długość szer. wysokość
KP2 201 /xx+2/ 40





mkfoam continental line

mkfoam continental line





Zestaw Box 74

Przekrój zestawu Box 74



wymiary materaca

90 x 200	
100 x 200	
120 x 200	
140 x 200	✓
160 x 200	✓
180 x 200	✓
200 x 200	

kolory tkanin

grupa 1	✓
grupa 2	✓
grupa 3	✓
grupa 4	✓
grupa 5	✓

* np. grupa 1 tkanin zaczyna się od 10XXX

Box 74-xx-50072
Ikaria H2 2SK MAX-xx-50072 / Lustro Silver Active
szafka 80674-50072

Box 74-xx-50074
Ikaria H2 2SK MAX-xx-50074 / Lustro Silver Active
szafka 80674-50074

Wymiary zewnętrzne podane w cm

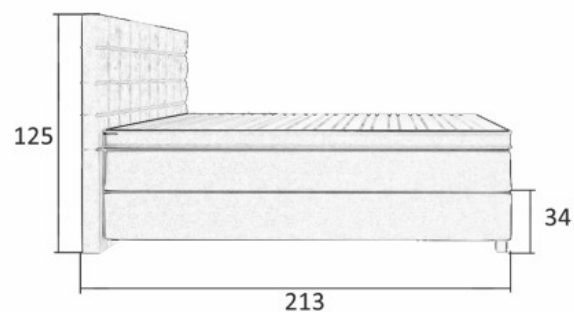
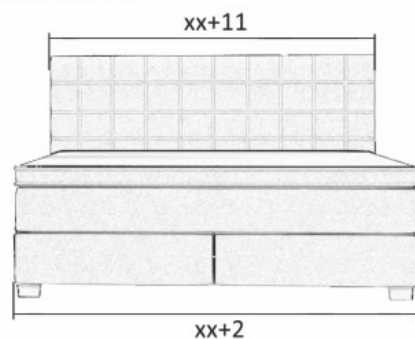

Zestaw Box 81 i 87

Zestaw Box 87

Przekrój zestawu Box 81



wymiary materaca

90 x 200	
100 x 200	
120 x 200	
140 x 200	✓
160 x 200	✓
180 x 200	✓
200 x 200	

kolory tkanin

grupa 1	✓
grupa 2	✓
grupa 3	✓
grupa 4	✓
grupa 5	✓

* np. grupa 1 tkanin zaczyna się od 10XXX

Box 81-xx-50071
 Onoder H2 2K4-xx-50071
 Orchilla Win Standard-xx-50071 / Lustro Tencel



Zestaw Box 81

Wymiary zewnętrzne podane w cm

Box 87-xx-30349
 Redina H2 2K4-xx-30349
 Orchilla Win Standard-xx-30349 / Lustro Tencel

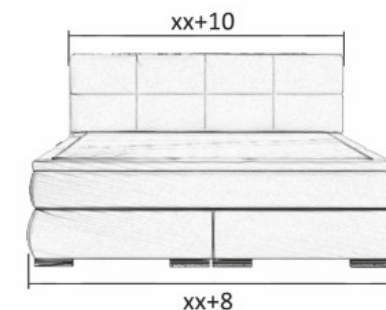
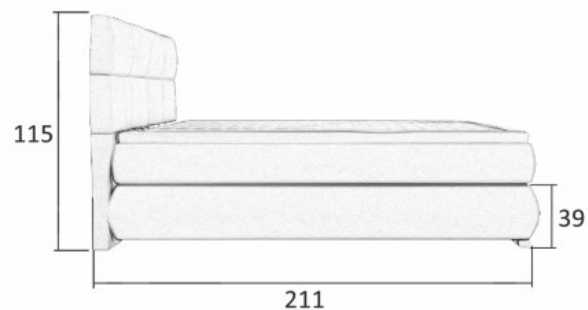

Zestaw Box 171



Zestaw Box 171

Przekrój zestawu Box 171



wymiary materaca

90 x 200	
100 x 200	
120 x 200	
140 x 200	✓
160 x 200	✓
180 x 200	✓
200 x 200	

kolory tkanin

grupa 1	✓
grupa 2	✓
grupa 3	✓
grupa 4	✓
grupa 5	✓

* np. grupa 1 tkanin zaczyna się od 10XXX

Box 171-xx-30355
Moli 2-xx-30355
Molina k max-xx-30355

Box 171-xx-50090
Moli 2-xx-50090
Molina k max-xx-50090

Wymiary zewnętrzne podane w cm

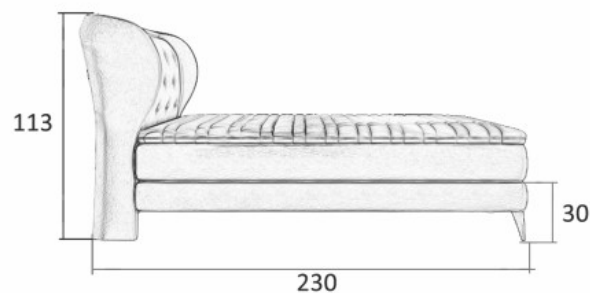
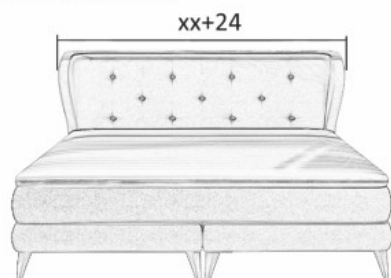

Zestaw Box 171



klasyczna nowoczesność

mkfoam exclusive line

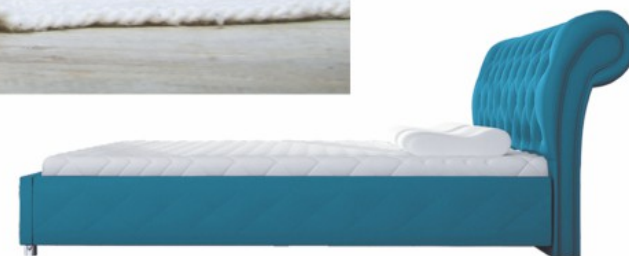

81211

81211-xx-40115
 stelaż wbudowany na listwach giętych
 materac Czwarty Etap Tencel



kolory tkanin

grupa 1	✓
grupa 2	✓
grupa 3	✓
grupa 4	✓
grupa 5	✓

* np. grupa 1 tkanin
 zaczyna się od 10XXX

81211-xx-40110
 stelaż wbudowany na listwach giętych
 materac Bahrain Naturalis



81211-xx-40103
 stelaż wbudowany na listwach giętych
 materac Medivis Silver Active

Wymiary zewnętrzne podane w cm

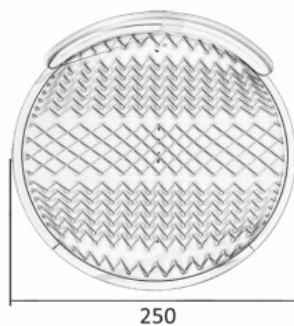

81224

Łóżko 81224-xx-30349/30355
np. stelaż Trioflex NV
Materac Sueno Lux Tencel



wymiary materaca

90 x 200	
100 x 200	
120 x 200	
140 x 200	✓
160 x 200	✓
180 x 200	✓
200 x 200	

kolory tkanin

grupa 1	✓
grupa 2	✓
grupa 3	✓
grupa 4	✓
grupa 5	✓

* np. grupa 1 tkanin zaczyna się od 10XXX

Łóżko 81224-xx-10107/10213
np. stelaż Favorit
Materac Sueno Minor LXI Soya



Wymiary zewnętrzne podane w cm

Łóżko 81224-xx-50070/20066
np. stelaż Duoflex NV
Materac Estrella Lux Silver Active

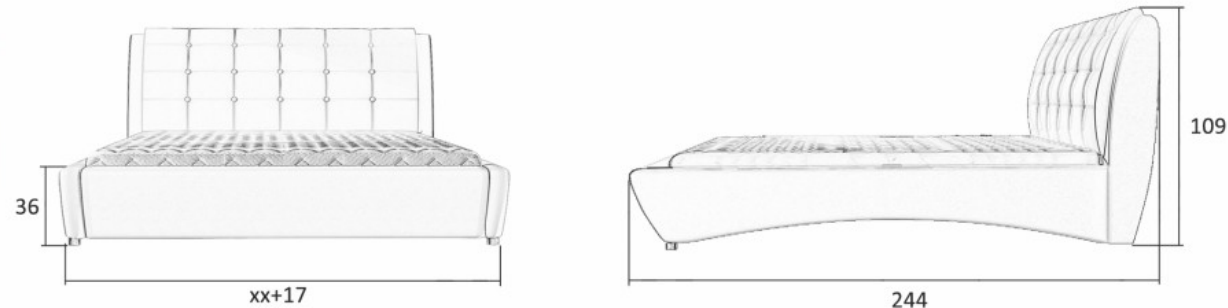



81206

łóżko 81206-xx-30352

np. stelaż Birkflex NV

Materac Venus Multi Pocket Silver Active



wymiary materaca

90 x 200	✓
100 x 200	✓
120 x 200	✓
140 x 200	✓
160 x 200	✓
180 x 200	✓
200 x 200	✓

kolory tkanin

grupa 1	✓
grupa 2	✓
grupa 3	✓
grupa 4	✓
grupa 5	✓

* np. grupa 1 tkanin zaczyna się od 10XXX

łóżko 81206-xx-40105

np. stelaż Trioflex NV

Materac Sueno Vital Tencel



łóżko 81206D-xx-20066
np. stelaż Duoflex NV
Materac Czar Nocy Tencel

MADE WITH
SWAROVSKI
ELEMENTS

Wymiary zewnętrzne podane w cm

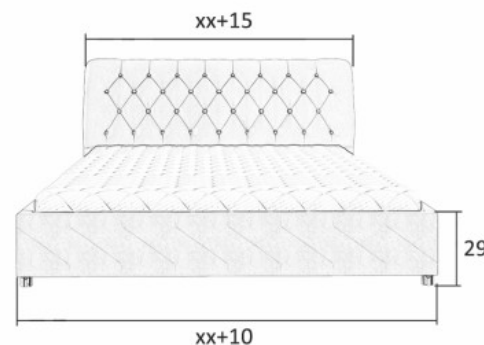
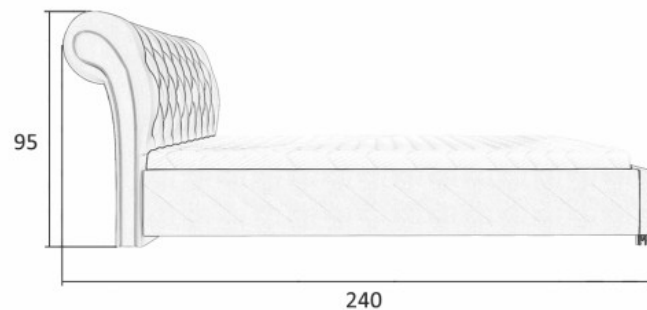

80266

Łóżko 80266-xx-20066
 np. stelaż Duoflex NV
 Materac Medivis Lux Tencel



wymiary materaca

90 x 200	
100 x 200	
120 x 200	
140 x 200	✓
160 x 200	✓
180 x 200	✓
200 x 200	✓

kolory tkanin

grupa 1	✓
grupa 2	✓
grupa 3	✓
grupa 4	✓
grupa 5	✓

* np. grupa 1 tkanin zaczyna się od 10XXX

Łóżko 80266-xx-40114
 np. stelaż Trioflex NV
 Materac Adam i Ewa Kieszonkowy Silver 600



Wymiary zewnętrzne podane w cm



Łóżko 80266-xx-40105
 np. stelaż Twinpack
 Materac Estrella Lux Tencel

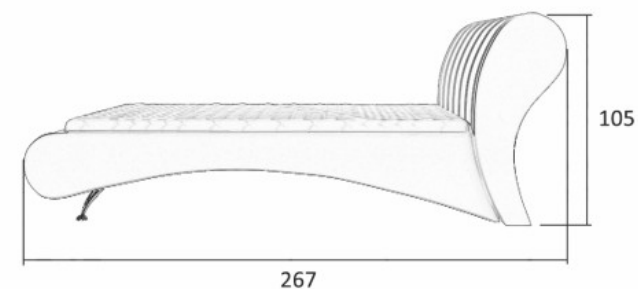



81229

łóżko 81229-xx-50078
np. stelaż Duoflex NV
Materac Czar Nocy Tencel



wymiary materaca

90 x 200	✓
100 x 200	
120 x 200	✓
140 x 200	✓
160 x 200	✓
180 x 200	✓
200 x 200	✓

kolory tkanin

grupa 1	✓
grupa 2	✓
grupa 3	✓
grupa 4	✓
grupa 5	✓

* np. grupa 1 tkanin
zaczyna się od 10XXX

łóżko 81229-xx-40104
np. stelaż Twinflex NV
Materac Adam i Ewa Elastik Mellow

łóżko 81229-xx-40103
np. stelaż Twinflex NV
Materac Czar Nocy Tencel

Wymiary zewnętrzne podane w cm

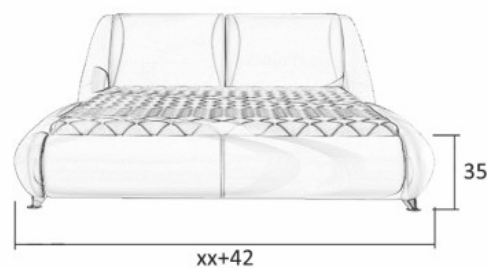
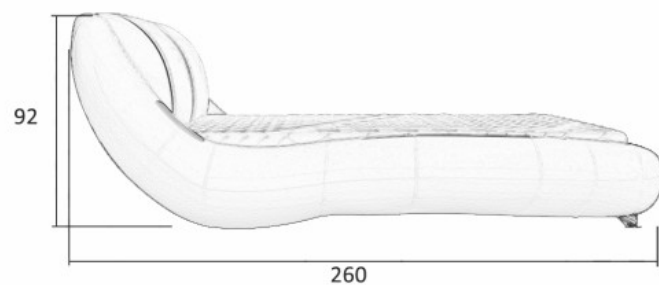

80282

łóżko 80282-xx-50073
 np. stelaż Trioflex NV
 Materac Sueno Vital Silver Active



wymiary materaca

90 x 200	✓
100 x 200	✓
120 x 200	✓
140 x 200	✓
160 x 200	✓
180 x 200	✓
200 x 200	

kolory tkanin

grupa 1	✓
grupa 2	✓
grupa 3	✓
grupa 4	✓
grupa 5	✓

* np. grupa 1 tkanin
 zaczyna się od 10XXX

łóżko 80282-xx-50068
 np. stelaż Favorit
 Materac Sueno Minor Silver Active



Wymiary zewnętrzne podane w cm

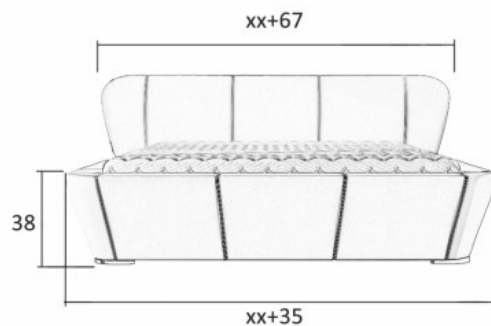

łóżko 80282-xx-40103
 np. stelaż Duoflex NV
 Materac Estrella Silver Active

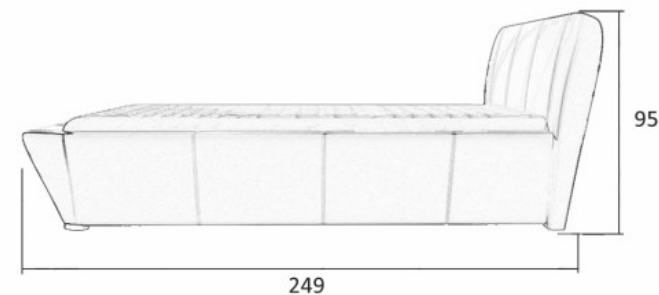



80295

Łóżko 80295-xx-30375
np. stelaż Birkflex NV
Materac Venus Multi Pocket Tencel



wymiary materaca

90 x 200	
100 x 200	
120 x 200	
140 x 200	✓
160 x 200	✓
180 x 200	✓
200 x 200	✓

kolory tkanin

grupa 1	✓
grupa 2	✓
grupa 3	✓
grupa 4	✓
grupa 5	✓

* np. grupa 1 tkanin
zaczyna się od 10XXX

Łóżko 80296-xx-30351
np. stelaż Trioflex NV
Materac Bahrain

Łóżko 80295-xx-50063
np. stelaż Duoflex NV
Materac Monaco

Wymiary zewnętrzne podane w cm

* dla łóżka 80296 wysokość zagłówka wynosi 98 cm,
szerokość xx+49, długość 242 cm
xx+64

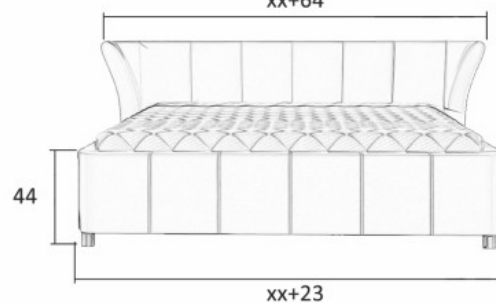
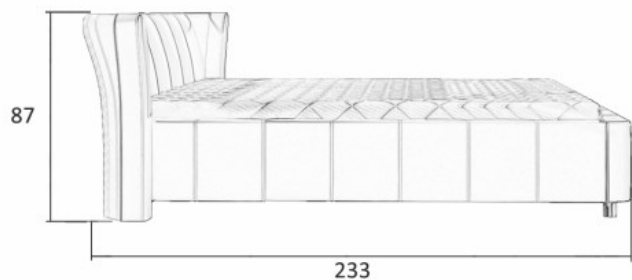

81207

Łóżko 81207-xx-40114/40103
 np. stelaż Trioflex NV
 Materac Estrella Lux Aloe Vera



wymiary materaca

90 x 200	
100 x 200	
120 x 200	
140 x 200	✓
160 x 200	✓
180 x 200	✓
200 x 200	

kolory tkanin

grupa 1	✓
grupa 2	✓
grupa 3	✓
grupa 4	✓
grupa 5	✓

* np. grupa 1 tkanin zaczyna się od 10XXX

Łóżko 81216-xx-40107/40115
 np. stelaż Duoflex NV
 Materac Sueno Minor LXI Silver Active



81216



Wymiary zewnętrzne podane w cm

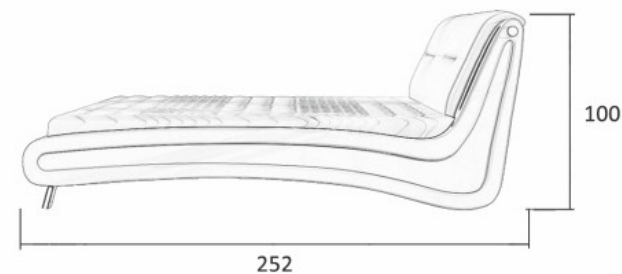
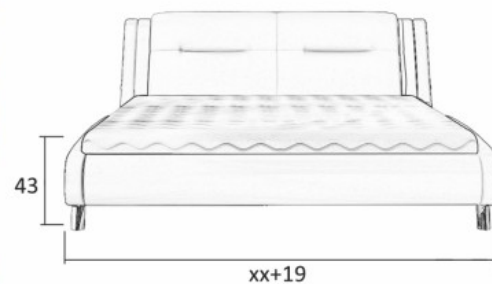

Łóżko 81207-xx-20054/20066
 np. stelaż Duoflex NV
 Materac Estrella Bio Aloe Vera

81234

łóżko 81234-xx-30352
np. stelaż Birkflex NV
Materac Bahrain Natural



wymiary materaca

90 x 200	✓
100 x 200	✓
120 x 200	✓
140 x 200	✓
160 x 200	✓
180 x 200	✓
200 x 200	✓

kolory tkanin

grupa 1	✓
grupa 2	✓
grupa 3	✓
grupa 4	✓
grupa 5	✓

* np. grupa 1 tkanin zaczyna się od 10XXX

łóżko 81234-xx-50073
np. stelaż Trioflex NV
Materac Sueno Vital Tencel



łóżko 81234-xx-30375
np. stelaż Birkflex NV
Materac Sueno Natural Tencel

Wymiary zewnętrzne podane w cm

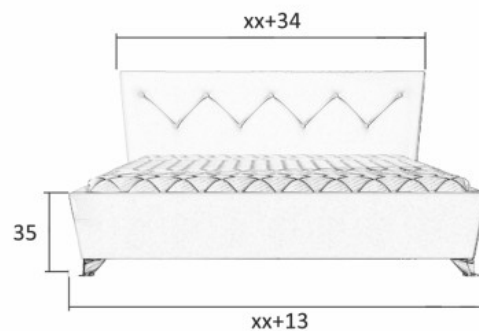
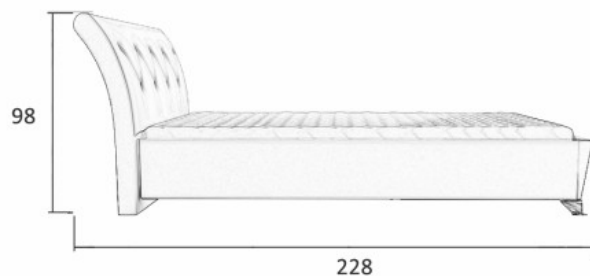



mkfoam modern line

klasyczna nowoczesność

81271



81277KF-xx-40104
materac Bahrain



wymiary materaca

90 x 200	✓
100 x 200	✓
120 x 200	✓
140 x 200	✓
160 x 200	✓
180 x 200	✓

kolory tkanin

grupa 1	✓
grupa 2	✓
grupa 3	✓
grupa 4	✓
grupa 5	✓

* np. grupa 1 tkanin zaczyna się od 10XXX

81274RM-xx-40102
materac Monaco



81271-xx-40103
np. stelaż Twinpack
Materac Medivis Tencel

Wymiary zewnętrzne podane w cm

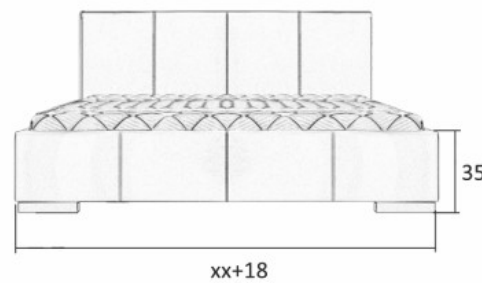
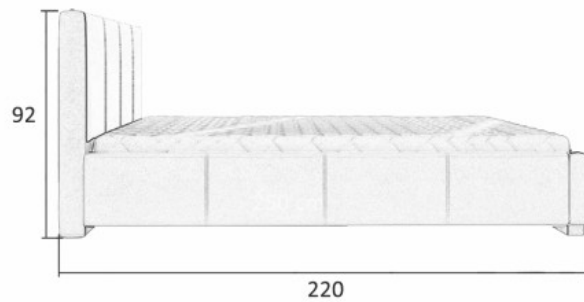

81275

Łóżko 81275RM-xx-40114
Materac Monaco



81275RM

wymiary materaca

90 x 200	✓
100 x 200	✓
120 x 200	✓
140 x 200	✓
160 x 200	✓
180 x 200	✓
200 x 200	✓

kolory tkanin

grupa 1	✓
grupa 2	✓
grupa 3	✓
grupa 4	✓
grupa 5	✓

* np. grupa 1 tkanin
zaczyna się od 10XXX

Łóżko 80270KF-xx-40103/40107
Materac Dual Silver Active



80270KF



Wymiary zewnętrzne podane w cm

* dla łóżka 80270 wysokość zagłówka wynosi 92 cm,
szerokość xx+18 i wysokość boku 36 cm

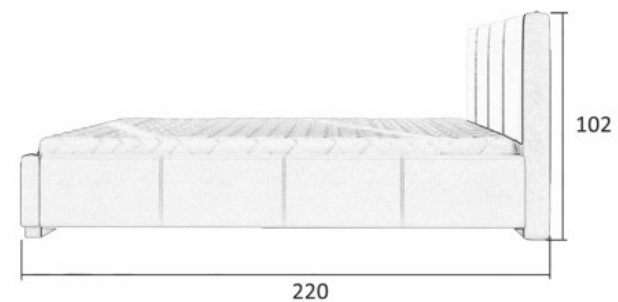
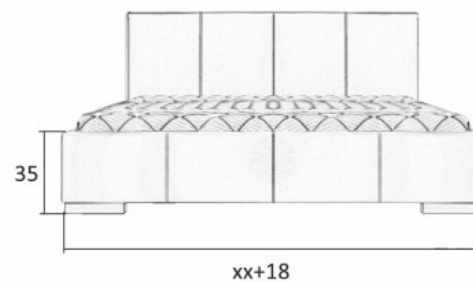

łóżko 81275-xx-40110
np. stelaż Brikflex NV
Materac Venus Multi Pocket Tencel

81272

Łóżko 81272-xx-30352
np. stelaż Duoflex NV
Materac Medivis Tencel



81272

wymiary materaca

90 x 200	✓
100 x 200	✓
120 x 200	✓
140 x 200	✓
160 x 200	✓
180 x 200	✓
200 x 200	✓

kolory tkanin

grupa 1	✓
grupa 2	✓
grupa 3	✓
grupa 4	✓
grupa 5	✓

* np. grupa 1 tkanin
zaczyna się od 10XXX

Łóżko 81272KF-xx-40107
Materac Sueno Lux Tencel



81272KF

Łóżko 81272-xx-40103
np. stelaż Twinflex NV
Materac Bahrain

Wymiary zewnętrzne podane w cm

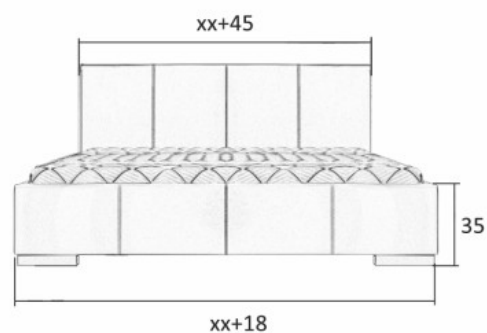
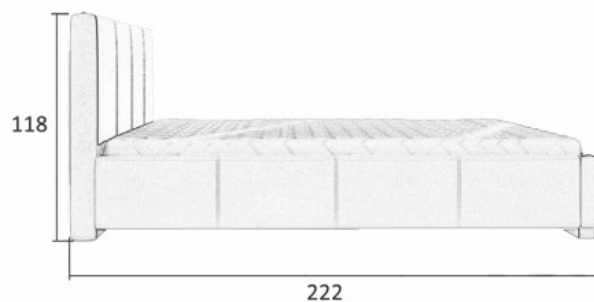

81231

łóżko 81231-xx-30379
np. stelaż Trioflex NV
Materac Sueno Soya



wymiary materaca

90 x 200	✓
100 x 200	✓
120 x 200	✓
140 x 200	✓
160 x 200	✓
180 x 200	✓
200 x 200	

kolory tkanin

grupa 1	✓
grupa 2	✓
grupa 3	✓
grupa 4	✓
grupa 5	✓

* np. grupa 1 tkanin
zaczyna się od 10XXX



łóżko 81231RM-xx-10107
Materac Sueno Minor LXI Aloe Vera



Wymiary zewnętrzne podane w cm

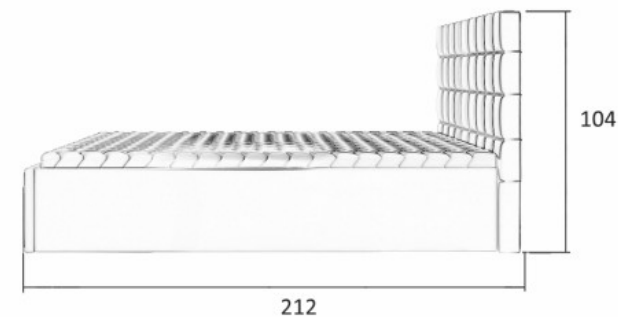
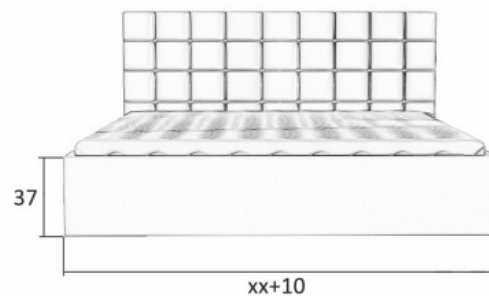

łóżko 81231-xx-30375
np. stelaż Duoflex NV
Materac Estrella Aloe Vera

81232

Łóżko 81232-xx-30349
np. stelaż Birkflex NV
Materac Venus Multi Pocket Soya



wymiary materaca

90 x 200	✓
100 x 200	✓
120 x 200	✓
140 x 200	✓
160 x 200	✓
180 x 200	✓
200 x 200	✓

kolory tkanin

grupa 1	✓
grupa 2	✓
grupa 3	✓
grupa 4	✓
grupa 5	✓

* np. grupa 1 tkanin
zaczyna się od 10XXX

Łóżko 81232RM-xx-50057
Materac Sueno Vital Aloe Vera



Łóżko 81232-xx-30352
np. stelaż Duoflex NV
Materac Estrella Aloe Vera

Wymiary zewnętrzne podane w cm

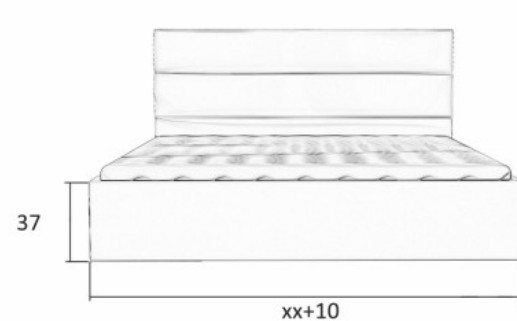
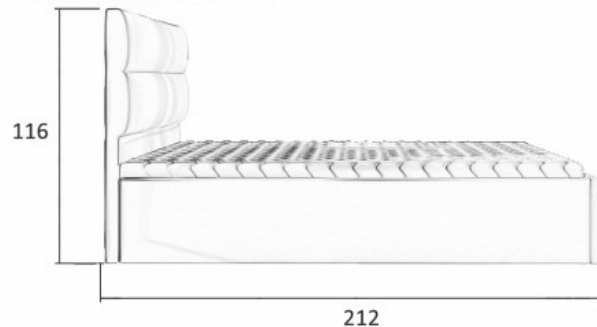

80218

Łóżko 80218-xx-50063
np. stelaż Trioflex NV
Materac Sueno Lux Tencel



wymiary materaca

90 x 200	✓
100 x 200	✓
120 x 200	✓
140 x 200	✓
160 x 200	✓
180 x 200	✓
200 x 200	

kolory tkanin

grupa 1	✓
grupa 2	✓
grupa 3	✓
grupa 4	✓
grupa 5	✓

* np. grupa 1 tkanin
zaczyna się od 10XXX

Łóżko 81210-xx-40111
np. stelaż Birkflex Side
Materac Sueno Minor LXI Silver Active



81210



Wymiary zewnętrzne podane w cm
* dla łóżka 81210 wysokość zagłówka wynosi 68 cm,
szerokość xx+12, długość 212 cm

Łóżko 80218-xx-40103
np. stelaż Duoflex NV
Materac Monaco

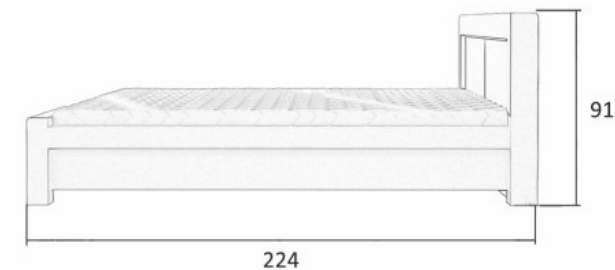
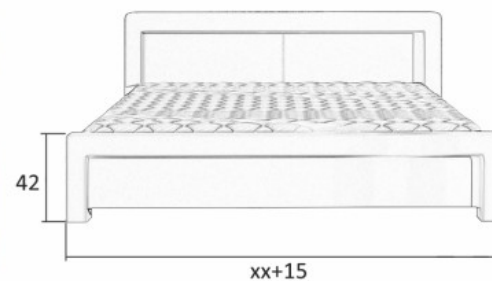

80219

Łóżko 80219KF-xx-30188
Materac Bahrain



wymiary materaca

90 x 200	✓
100 x 200	✓
120 x 200	✓
140 x 200	✓
160 x 200	✓
180 x 200	✓
200 x 200	✓

kolory tkanin

grupa 1	✓
grupa 2	✓
grupa 3	✓
grupa 4	✓
grupa 5	✓

* np. grupa 1 tkanin zaczyna się od 10XXX

Łóżko 80219-xx-40144
np. stelaż Trioflex NV
Materac Sueno Vital Tencel

Łóżko 80219RM-xx-40115
Materac Estrella Lux Tencel

Wymiary zewnętrzne podane w cm

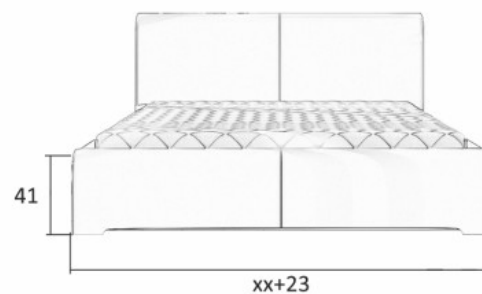
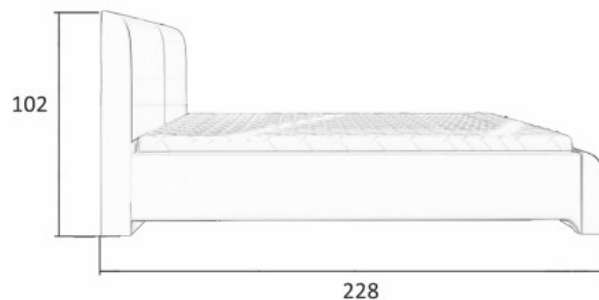

80264

Łóżko 80265-xx-30354
np. stelaż Brikflex NV
Materac Monaco



wymiary materaca

90 x 200	
100 x 200	
120 x 200	
140 x 200	✓
160 x 200	✓
180 x 200	✓
200 x 200	

kolory tkanin

grupa 1	✓
grupa 2	✓
grupa 3	✓
grupa 4	✓
grupa 5	✓

* np. grupa 1 tkanin
zaczyna się od 10XXX

Łóżko 80263-xx-40110
np. stelaż Twinpack
Materac Ibiza Silver Active



Wymiary zewnętrzne podane w cm
* dla łóżka 80263 długość wynosi 221 cm

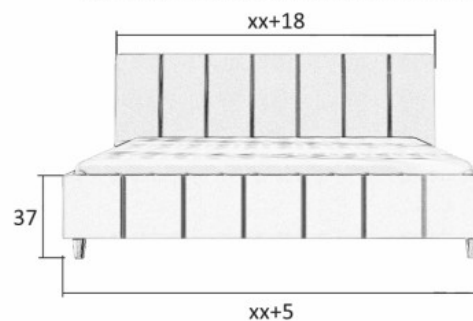

Łóżko 80264-xx-30350
np. stelaż Brikflex NV
Materac Medivis Aloe Vera
szafka 80687-30350

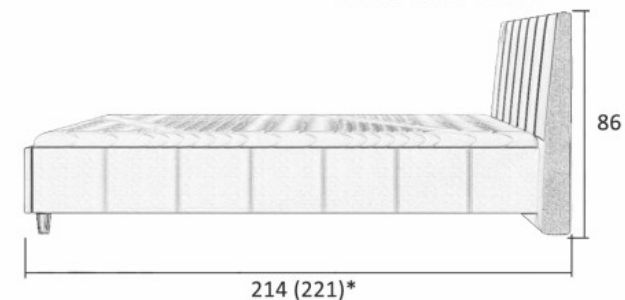



81218

łóżko 81217KF-xx-40114
Materac Dubai Lux Cotton



81217KF

wymiary materaca

90 x 200	✓
100 x 200	✓
120 x 200	✓
140 x 200	✓
160 x 200	✓
180 x 200	✓
200 x 200	✓

kolory tkanin

grupa 1	✓
grupa 2	✓
grupa 3	✓
grupa 4	✓
grupa 5	✓

* np. grupa 1 tkanin zaczyna się od 10XXX

łóżko 81205RM-xx-50067
Materac Sueno Lux Tencel



81205RM

łóżko 81218-xx-40103
np. stelaż Twinflex NV
Materac Czar Nocy Tencel

Wymiary zewnętrzne podane w cm

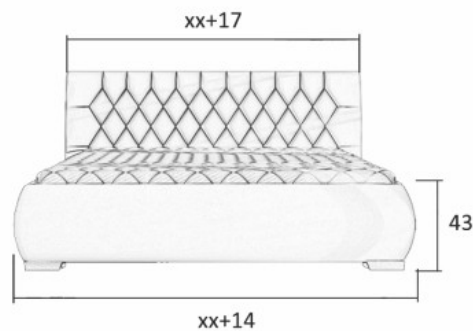
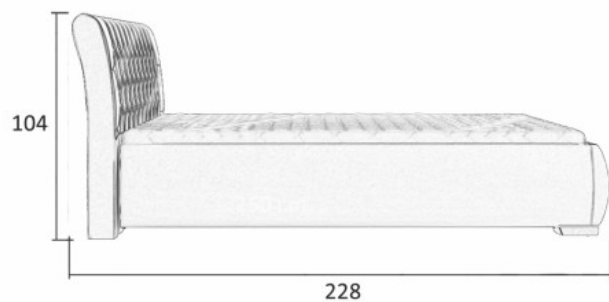

DODATKI DO BOX MULTISYSTEM i ŁÓŻEK

Szafka 80674



Szafka 80683



Szafka 80684



Szafka 80685



Szafka 80686



Szafka 80687

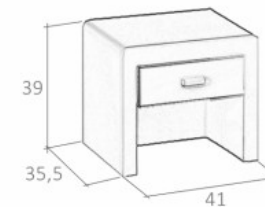

Szafka 80670



Szafka 80671



Szafka 80675

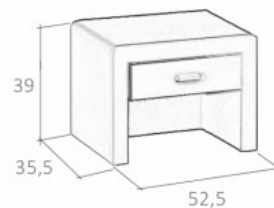

Szafka 80679

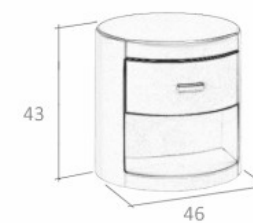

Pufa 80680

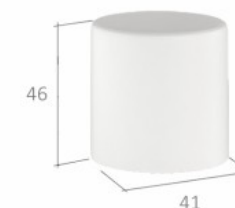

Komoda 80672

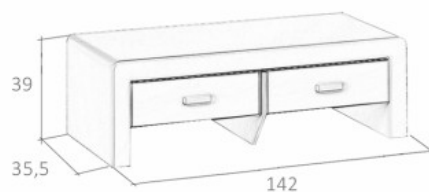

Toaletka 80678

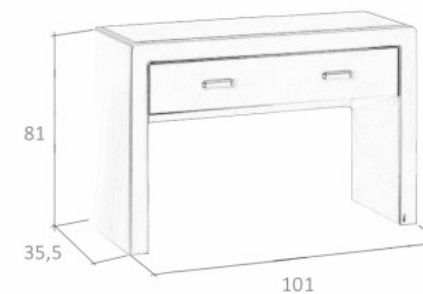

Komoda 81691

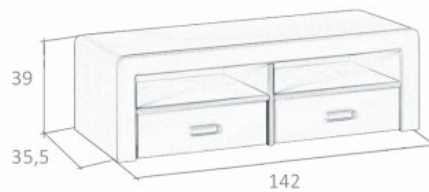

Komoda 80676



Komoda 80673



Komoda 80677

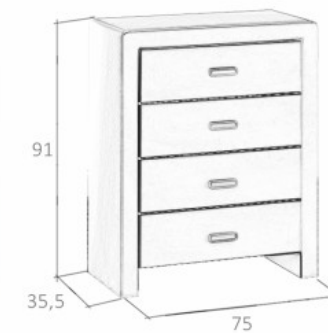

wymiary zewnętrzne podane w cm

symp. szer. kolor 80000 - xx - xx	łóżko	(08) 80x200	(09) 90x200	(10) 100x200	(12) 120x200	(14) 140x200	(16) 160x200	(18) 180x200	(20) 200x200
80209-xx-xx 80209KF-xx-xx 80209RM-xx-xx			✓	✓	✓	✓	✓	✓	
80212-xx-xx						✓	✓	✓	
80213-xx-xx						✓	✓	✓	
80218-xx-xx			✓	✓	✓	✓	✓	✓	
80219-xx-xx 80219KF-xx-xx 80219RM-xx-xx			✓	✓	✓	✓	✓	✓	
80220-xx-xx			✓	✓	✓	✓	✓	✓	
80242-xx-xx			✓		✓	✓	✓	✓	
80259-xx-xx						✓	✓	✓	
80262-xx-xx			✓		✓	✓	✓	✓	
80263-xx-xx			✓	✓	✓	✓	✓	✓	✓
80264-xx-xx			✓	✓	✓	✓	✓	✓	✓
80265-xx-xx			✓	✓	✓	✓	✓	✓	✓
80266-xx-xx						✓	✓	✓	
80270-xx-xx 80270KF-xx-xx 80270RM-xx-xx			✓	✓	✓	✓	✓	✓	
80271-xx-xx 80271KF-xx-xx 80271RM-xx-xx			✓	✓	✓	✓	✓	✓	
80272-xx-xx 80272KF-xx-xx 80272RM-xx-xx			✓	✓	✓	✓	✓	✓	
80277-xx-xx 80277KF-xx-xx 80277RM-xx-xx			✓	✓	✓	✓	✓	✓	
80282-xx-xx 80282KF-xx-xx 80282RM-xx-xx			✓	✓	✓	✓	✓	✓	
80295-xx-xx 80295KF-xx-xx						✓	✓	✓	
80296-xx-xx 80296KF-xx-xx						✓	✓	✓	
80297-xx-xx						✓	✓	✓	
81205-xx-xx 81205KF-xx-xx 81205RM-xx-xx			✓	✓	✓	✓	✓	✓	

symp. szer. kolor 80000 - xx - xx	łóżko	(08) 80x200	(09) 90x200	(10) 100x200	(12) 120x200	(14) 140x200	(16) 160x200	(18) 180x200	(20) 200x200
81206-xx-xx			✓	✓	✓	✓	✓	✓	
81207-xx-xx						✓	✓	✓	
81210-xx-xx			✓				✓	✓	
81211-xx-xx		materac okrągły o średnicy 230 cm							
81216-xx-xx						✓	✓	✓	
81217-xx-xx 81217KF-xx-xx 81217RM-xx-xx			✓	✓	✓	✓	✓	✓	
81218-xx-xx 81218KF-xx-xx 81218RM-xx-xx						✓	✓	✓	
81224-xx-xx						✓	✓	✓	
81228-xx-xx 81228KF-xx-xx 81228RM-xx-xx						✓	✓	✓	
81229-xx-xx			✓	✓	✓	✓	✓	✓	
81231-xx-xx 81231KF-xx-xx 81231RM-xx-xx			✓	✓	✓	✓	✓	✓	
81232-xx-xx 81232KF-xx-xx 81232RM-xx-xx			✓	✓	✓	✓	✓	✓	
81234-xx-xx			✓	✓	✓	✓	✓	✓	✓
81270-xx-xx 81270KF-xx-xx 81270RM-xx-xx			✓	✓	✓	✓	✓	✓	
81271-xx-xx 81271KF-xx-xx 81271RM-xx-xx			✓	✓	✓	✓	✓	✓	
81272-xx-xx 81272KF-xx-xx 81272RM-xx-xx			✓	✓	✓	✓	✓	✓	
81274-xx-xx 81274KF-xx-xx 81274RM-xx-xx			✓	✓	✓	✓	✓	✓	
81275-xx-xx 81275KF-xx-xx 81275RM-xx-xx			✓	✓	✓	✓	✓	✓	
81277-xx-xx 81277KF-xx-xx 81277RM-xx-xx			✓	✓	✓	✓	✓	✓	

Zmiany zastrzeżone

Kolorystyka zdjęć może różnić się od odcieni rzeczywistych.

Podane wymiary rzeczywiste produktów mogą się różnić o +/-1cm z uwagi na różnorodność materiałów obiciowych oraz specyfikę produktów.
Informacje zawarte w katalogu nie stanowią oferty handlowej w rozumieniu zapisów Kodeksu cywilnego i są publikowane wyłącznie w celu informacyjnym.



zeskanuj kod lub wejdź na:

www.160x200.pl

Szanowny Kliencie!

Mamy nadzieję, że spodoba ci się nasz katalog i znajdziesz dzięki niemu coś dla siebie

Nie wyrzucaj go - przekaz dalej znajomym, by także mogli z niego skorzystać

Nie niszcząc go, wspólnie zadbamy o nasze lasy i środowisko naturalne z obustronną korzyścią